

PERFORMANCE DATA NO LOAD & NO DOOR OPENINGS AT 0° F FREEZER & 37° F FRESH FOOD (2500 ++ ISO)				
Type A with Run/Start Capacitor	65°F (18°C) Ambient		90°F (32°C) Ambient	
	Variable Speed	Standard	Variable Speed	Standard
Operating Time	74 to 84%	32 to 40%	100%	55 to 65%
Freezer Temperature	-2° to 2° F -19° to -17° C	0° to 4° F -18° to -16° C	-1° to 3° F -18° to -16° C	-1° to 3° F -18° to -16° C
Refrigerator Temperature	34° to 39° F 1° to 4° C	34° to 39° F 1° to 4° C	34° to 39° F 1° to 4° C	34° to 39° F 1° to 4° C
Low Side Pressure (cut-in)	5 to 12 psig 43 to 83 kPa	5 to 12 psig 43 to 83 kPa	N/A	5 to 12 psig 43 to 83 kPa
Low Side Pressure (cut-out)	-2 to 2 psig -14 to 14 kPa	-2 to 2 psig -14 to 14 kPa	-2 to 2 psig -14 to 14 kPa	-2 to 2 psig -14 to 14 kPa
High Side Pressure (last 1/3 cycle)	90 to 105 psig 621 to 724 kPa	90 to 115 psig 621 to 793 kPa	120 to 135 psig 827 to 931 kPa	130 to 155 psig 896 to 1069 kPa
Wattage (last 1/3 cycle)	50 to 60	90 to 130	60 to 70	100 to 140
Amps (running)	0.5 to 0.9	0.7 to 1.1	0.6 to 1.0	0.8 to 1.2
Base Voltage	115 vac (127 vac max)			

DEFROST SPECIFICATIONS

Cabinet Size	Thermal Cut-out		Heater		Defrost Thermistor Termination
	Cut-in	Cut-out	Watts	Ohms	Cut-out
23' CD, 26' SD	110° F (43.3° C)	135° F (52.2° C)	450	30	48° F (8° C)

CONDENSER FAN MOTOR

Watts	RPM	Amps
3.1	1100 CW Opposite Shaft	0.03 Running

ICE MAKER DIAGNOSTIC MODE

Activate:	Press FZ+ and FF+ temperature pads for up to 10 sec. simultaneously. Press FF+ or - to move forward or backward through tests.		
Deactivate:	Press FF+ for up to 10 sec. IM Diagnostic Mode will automatically deactivate after 5 min. of inactivity. NOTE: Silence alarm.		
Test	To activate test	Passing Result	
52C	Ice Maker Thermistor	Activates automatically	FZ display shows temperature sensed by Ice Maker Thermistor. "OP" if open; "SH" if short
55C	Water Valve	Press Power On-Off	Remove ice tray to collect water into a measuring container to measure water fill. If collecting water into ice tray, first perform test 63C to empty ice tray.
58C	Ice Level Sensor	Activates automatically	Remove ice bucket. Allow bail arm to drop freely. Pass if no alarm when tray returns to "home" position. Hold bail arm up. Pass if alarm sounds when tray returns to "home" position. This test runs continuously until another test is selected.
63C	Twist Tray	Press Power On-Off	Remove ice bucket. FZ display shows "1" and "GOOD".

SERVICE DATA SHEET

A01461105

ICE & WATER - AUTOMATIC DEFROST SIDE BY SIDE - R134a

IMPORTANT: PLEASE RETURN THIS SHEET TO ITS ORIGINAL LOCATION

ERROR CODES			SPECIAL MODES				
Display	FZ	FF	Interpretation	Mode	Display		Activate/Deactivate (press for up to 10 sec. simultaneously)
					FZ	FF	
--	OP		Open FF mid-level thermistor	Manual Defrost	d	F	+ and -/same to deactivate
OP	--		Open FZ thermistor	Display/Showroom	77	77	^ and -/set
				Sabbath	Sb	Sb	V and +/same to deactivate
--	SH		Shorted FF mid-level thermistor	Diagnostic	No FF or FZ display, all UI LEDs on.		^ and V/+ to deactivate
SH	--		Shorted FZ thermistor	Notes:			
SY	CF		UI to Main Control Board communication failure; on start up	<ul style="list-style-type: none"> Always check for pin back-outs, pinched or damaged wires before replacing components. Determine whether failure is caused by the component, main control board or wiring. Contact TID before replacing main control board. Refer to Service Manual for additional information. 			
SY	CE		UI Main Control Board communication error; after a period in operation				
SY	EF		Evaporator fan failure				

VCC Resistance Check

Check resistance between terminals 1 and 2, 2 and 3, 3 and 1. If all resistances are equal, compressor is operative.

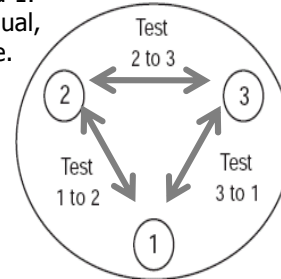

IMPORTANT SAFETY NOTE

The information provided herein is designed to assist qualified repair personnel only. Untrained persons should not attempt to make repairs due to the possibility of electrical shock. Disconnect power cord before servicing this appliance.

IMPORTANT

If any green grounding wires are removed during servicing, they must be returned to their original position and properly secured.



CAUTION

All electrical parts and wiring must be shielded from torch flame. DO NOT allow torch to touch insulation; it will char at 200°F and flash ignite (burn) at 500°F. Excessive heat will distort the plastic liner.

DIAGNOSTIC MODE

Activate:	Press ^ and V temperature pads for up to 10 sec. simultaneously. Press + to advance through tests.		
Deactivate:	Press + for up to 10 sec. Diagnostic Mode will automatically deactivate after 5 min. of inactivity. Note: Silence alarm.		
<ul style="list-style-type: none"> Tests marked with "*" may not be applicable to this unit and will not be displayed in Diagnostic Mode. Tests displayed in diagnostic mode but not described below are for internal purposes only; advance through. View UI display for "on", "off", "CL", "OP", "SH", "LO", "HI" or numerical results of tests. Listen for operating sounds; feel for heat or air flow as appropriate to determine results of tests. 			
Test	To activate test:	Passing result	
--	First Screen	--	All LED lights on UI illuminated
--	Second Screen	--	All segments on UI temperature displays illuminated
--	Third Screen	--	Blank UI display, no lights illuminated, no shadowing; "-" and "+" blinking on FF display side to show location.
28	Dispenser Paddle	Press disp. paddle	"on" on UI when depressed; "off" when released
46	Humidity Sensor	Activates automatically	"OP" if open, "SH" if short AC Heater System: Displays %RH DC Heater System: "HI" - heater should be on "Lo" - heater should be off %RH is displayed when humidity is between "Lo" and "HI" values; heater could be on or off.
47*	Dispenser Pocket Heater	Press set	AC Heater System: "--"; test not available DC Heater System: heater on when "on", off when "off"
1*	Standard Compressor and Condenser Fan	Press set	Compressor and Condenser Fan running when "on"; stopped when "off"
2	Defrost Heater	Press set	Defrost limit switch must be closed; verify "CL" in test 26. Feel for heat from defrost heater when "on". If "OP" in test 26, heater will not activate.
8	Water Valve (Dispenser)	Press set	Be prepared to collect water at dispenser. Water dispenses when "on"; stops when "off"
10	Auger Motor	Press set	FZ door must be closed. Motor running when "on"; motor stopped when "off"
11	Cube/Crush Solenoid	Press set	Do not leave solenoid in activated state. Solenoid activated when "on"; deactivated when "off"
12*	VCC Condenser Fan	Press set	Fan running when "on"; stopped when "off"
38*	VCC Compressor	Press set	Compressor running when "on"; stopped when "off"
13	FF Light (LED Models)	Press set	FF Lights on when "on"; off when "off"
15	Evaporator Fan	Press set	Press to toggle between "Off", "LO", and "HI". A current sensor reading is flashed (units are not mA). Off reading should be around 1. "LO" speed reading should settle down around 10. "HI" speed reading should settle down around 53.
20	FZ Light (LED Models)	Press set	FZ Lights on when "on"; off when "off"
22	Damper	Press set	With inspection mirror, observe damper open when "OP"; closed when "CL"
36	Ice Chute Door	Depress ice chute door or press set	"OP" on UI when manually opened; "CL" when closed. Or, using "set", "OP" on UI when fully opened or "CL" when fully closed by the motor.
23	FF Door	Open/close FF door	"CL" on UI when door closed; "OP" when open
24	FZ Door	Open/close FZ door	"CL" on UI when door closed; "OP" when open
26	Defrost Limit Switch	Activates automatically	"CL" on UI when closed; "OP" when open
29	FF Thermistor	Activates automatically	UI shows temperature sensed by FF thermistor; pass if within 10°F of temperature measured with gauge at mid-level FF thermistor location. "OP-" if open; "SH-" if short
30	FZ Thermistor	Activates automatically	UI shows temperature sensed by FZ thermistor; pass if within 10°F of temperature measured with gage at FZ thermistor location. "OP" if open; "SH" if short
33	Ambient Thermistor @ Main Board	Activates automatically	UI shows temperature sensed at main board; pass if within +20°F/-10°F of temperature measured with gauge at main board location. "OP" if open; "SH" if short
34	Ambient Thermistor @ UI	Activates automatically	UI shows temperature sensed at UI; pass if within +20°F/-10°F of temperature measured with gauge at UI location. "OP" if open; "SH" if short
39	Evaporator Thermistor	Activates automatically	UI shows temperature sensed at main board; pass if within +20°F/-10°F of temperature measured with gauge at evaporator thermistor location. "OP" if open; "SH" if short
0-	Firmware Parameters	Press set	Displays digit sequence; record
2-	Main Board Firmware	Press set	Displays digit sequence; record
4-	UI Firmware	Press set	Displays digit sequence; record

REFRIGERATOR LEDS

ID	LOCATION
RG-1	LOWER RIGHT
RG-2	MIDDLE RIGHT
RG-3	UPPER RIGHT
RG-4	TOP REAR
RG-5	TOP FRONT
RG-6	LOWER LEFT
RG-7	MIDDLE LEFT
RG-8	UPPER LEFT
RG-9	TOP FRONT

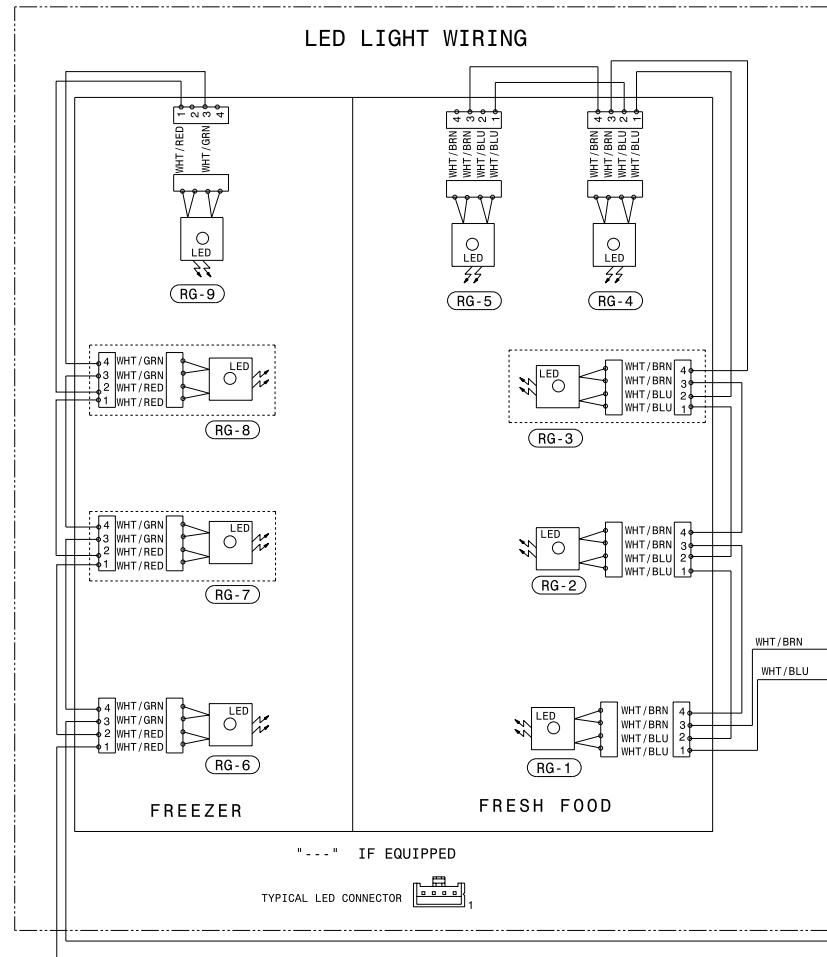

INLINE CONNECTOR ABBREVIATION KEY	
ABBR.	EXPLANATION
IM1	12 PIN CONNECTION IN FREEZER COMPARTMENT ICEMAKER
IM2	6 PIN CONNECTION TO ICEMAKER ELECTROMECHANICS
LS1	9 PIN LOW SIDE EVAPORATOR COMPARTMENT
MC1	12 PIN CONNECTION LEFT OF THE COMPRESSOR
FZ1	6 PIN CONNECTION NEAR MAIN BOARD
RH1/LH1	2 PIN CONNECTION DOOR SWITCH
DOOR	3 PIN CONNECTION AT LEFT HINGE
FZLED	2 PIN CONNECTION NEAR MAIN BOARD CONNECT TO FF AND FZ LED HARNESS

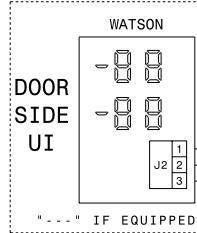
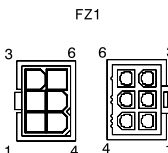
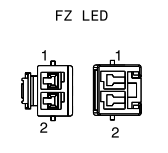
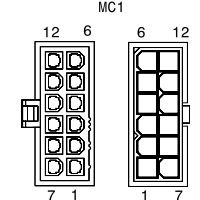
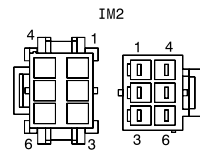
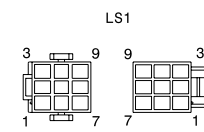
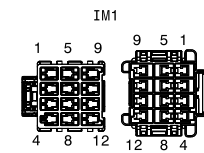
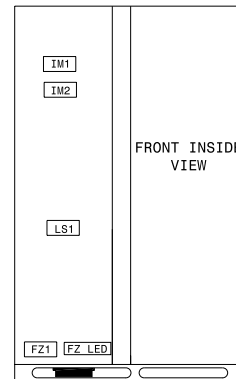
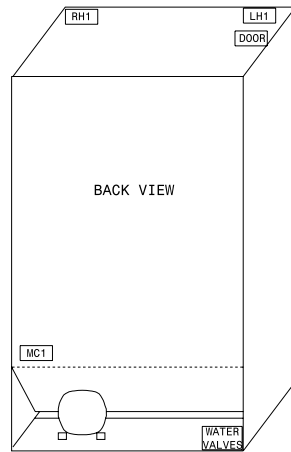

DC DISPENSER HEATER

