

PRODUCT MODEL NUMBERS

KRFC704F KRFC604F

Electrical: A 115-volt, 60 Hz, AC-only 15- or 20-amp fused, grounded electrical supply is required. It is recommended that a separate circuit serving only your refrigerator and approved accessories be provided. Use an outlet that cannot be turned off by a switch. Do not use an extension cord.

Water: A cold water supply with water pressure between 35 and 120 psi (241 and 827 kPa) is required to operate the water dispenser and ice maker. If you have questions about your water pressure, call a licensed, qualified plumber.

NOTE: If the water pressure is less than what is required, the flow of water from the water dispenser could decrease or ice cubes could be hollow or irregular shaped.

Reverse Osmosis Water Supply:

IMPORTANT: The pressure of the water supply coming out of a reverse osmosis system going to the water inlet valve of the refrigerator needs to be between 35 and 120 psi (241 and 827 kPa).

If a reverse osmosis water filtration system is connected to your cold water supply, the water pressure to the reverse osmosis system needs to be a minimum of 40 to 60 psi (276 to 414 kPa).

PRODUCT DIMENSIONS

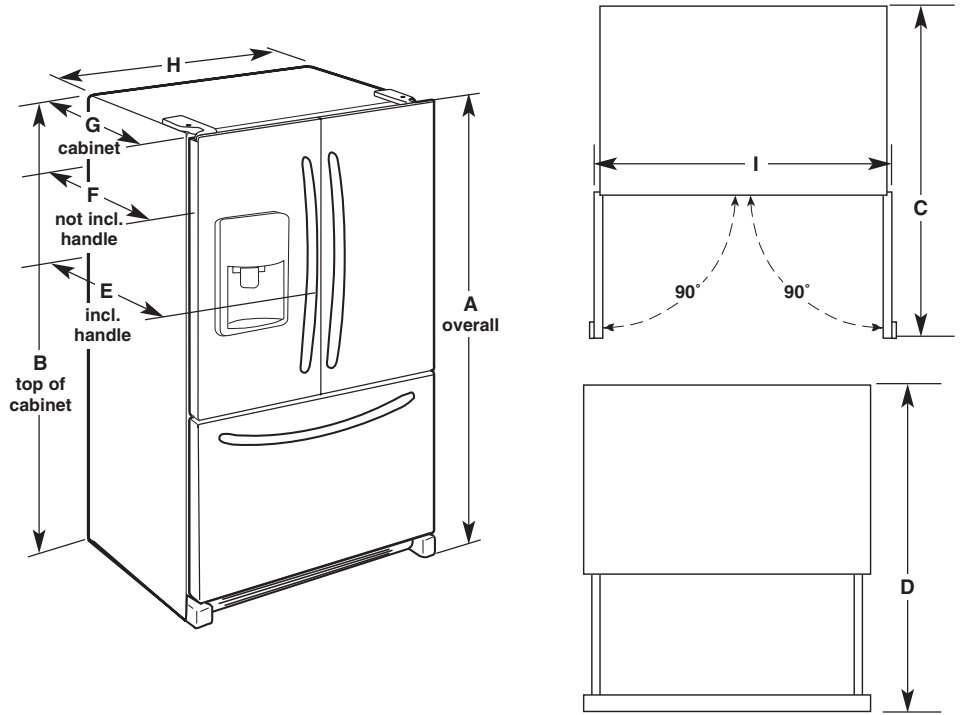

Model Size	Height - Overall "A"	Height - Top of Cabinet "B"	Depth - Door Open 90° "C"	Depth - Drawer Open "D"	Depth - With Handles "E"	Depth - Without Handles "F"	Depth - Cabinet Only "G"	Width - Cabinet "H"	Width - Door Open 90° "I"
23.8 cu. ft.	71 ⁷ / ₈ " (182.6 cm)	70 ⁷ / ₈ " (180.0 cm)	43 ³ / ₄ " (111.1 cm)	45 ⁷ / ₈ " (116.5 cm)	31 ¹ / ₂ " (80.0 cm)	28 ⁷ / ₈ " (73.3 cm)	24 ³ / ₈ " (61.9 cm)	35 ⁵ / ₈ " (90.5 cm)	43 ⁵ / ₈ " (110.8 cm)

LOCATION REQUIREMENTS

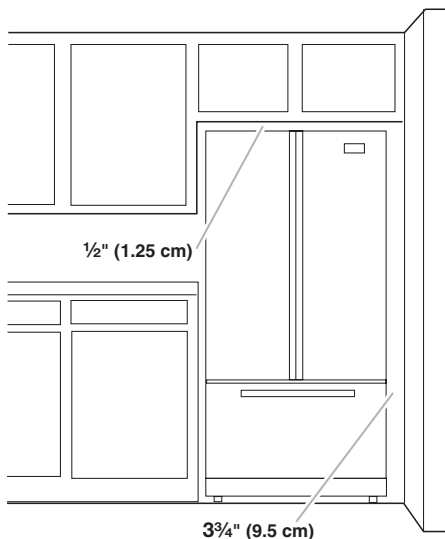

IMPORTANT: This refrigerator is designed for indoor, household use only.

To ensure proper ventilation for your refrigerator, allow for a 1/2" (1.25 cm) of space on each side and at the top. Allow for a 1" (2.54 cm) space behind the refrigerator. If your refrigerator has an ice maker, allow extra space at the back for the water line connections. When installing your refrigerator next to a fixed wall, leave a 3/4" (9.5 cm) minimum space between the refrigerator and wall to allow the door to swing open.

NOTE: This refrigerator is intended for use in a location where the temperature ranges from a minimum of 55°F (13°C) to a maximum of 110°F (43°C). The preferred room temperature range for optimum performance, which reduces electricity usage and provides superior cooling, is between 60°F (15°C) and 90°F (32°C). It is recommended that you do not install the refrigerator near a heat source, such as an oven or radiator.