



DeltaWing™



OWNER'S MANUAL

**Read and understand this entire manual before allowing child to use this product! For assistance contact Razor.
DO NOT RETURN TO STORE.**

**NOTE: Manual illustrations are for demonstration purposes only.
Illustrations may not reflect exact appearance of actual product.
Specifications subject to change without notice.**

**Please have your product along with the 22 character product I.D. code with you
before contacting Razor for warranty assistance and/or replacement parts.**

Product I.D. Code: _____ - _____ - _____

CONTENTS

Safety Warnings	1	Repair and Maintenance.....	5
Before You Begin.....	2	DeltaWing Parts.....	6
Assembly and Set-Up.....	3	Warranty and Contact Information	7
Pre-Ride Checklist and Usage.....	4		

SAFETY WARNINGS

! AN IMPORTANT MESSAGE TO PARENTS: This manual contains many warnings and cautions concerning the consequences of failing to maintain, inspect or properly use your DeltaWing™. Because any incident can result in serious injury or even death, we do not repeat the warning of potential serious injury or death each time such a possibility is mentioned.

! GENERAL WARNING: Riding the DeltaWing can be a hazardous activity. Certain conditions may cause the equipment to fail without fault of the manufacturer. Like other wheeled products, the DeltaWing can and is intended to move, and it is therefore possible to lose control, fall off and/or get into dangerous situations that no amount of care, instruction or expertise can eliminate. If such things occur, your child can be seriously injured or die, even when using safety equipment and other precautions. USE COMMON SENSE.

APPROPRIATE RIDER USE AND PARENTAL SUPERVISION

Direct adult supervision is required at all times. This manual contains important safety information. It is your responsibility to review this information and make sure that all children obey all warnings, cautions, instructions and safety topics, and assure that young riders are able to safely use this product. Razor USA recommends that you periodically review and reinforce the information in this manual with young riders, and that you inspect and maintain your children's product to ensure their safety.

The recommended rider age of 6 years and older for the DeltaWing is only an estimate, and can be affected by the rider's size, weight or ability. Any child unable to fit comfortably on the DeltaWing should not attempt to ride it.

A parent's decision to allow his or her child to ride this product should be based on the child's maturity, skill and ability to follow rules.

Do not exceed 143 lb (65 kg) on the DeltaWing.

Rider weight does not necessarily mean a child's size is appropriate to fit or maintain control of the DeltaWing.

ACCEPTABLE RIDING PRACTICES AND CONDITIONS

Direct parental supervision is required. The DeltaWing is meant to be used only in controlled environments, free of potential traffic hazards and not on public streets. Do not allow your child to ride the DeltaWing in any areas where vehicle traffic is present. Child must maintain a hold on the handlebars at all times. Never allow more than one child at a time to ride the DeltaWing. Never use near steps, sloped driveways, hills, roadways, alleys or swimming pool areas.

Do not ride the DeltaWing in wet weather. The DeltaWing is intended for use on solid, flat, clean and dry surfaces, such as pavement or level ground, without loose debris such as rocks or gravel. Wet, slick or uneven and rough surfaces may impair traction and contribute to possible accidents. Do not ride the DeltaWing in mud, ice, puddles or water. Avoid excessive speeds that can be associated with downhill rides. Never risk damaging surfaces, such as carpet or flooring, by use of a DeltaWing indoors. Do not ride at night or when visibility is impaired.

PROPER RIDING ATTIRE

Always ensure child is wearing proper protective equipment, such as an approved safety helmet. A helmet may be legally required by local law or regulation in your area. A child should always wear shoes and keep shoelaces tied and out of the way of the wheels. Never ride barefooted or in sandals. Knee pads and elbow pads are recommended.

! WARNING: ALWAYS INSPECT DELTAWING PRIOR TO RIDING. Properly inspecting and maintaining your DeltaWing can reduce the risk of injury. Always inspect your DeltaWing before riding and regularly maintain it.

! WARNING: CHECK LOCAL LAWS REGARDING DELTAWING USE. Check local laws and regulations to see where and how you may use your Razor DeltaWing legally. In many states and local areas, DeltaWing riders may be required BY LAW to wear a helmet. Check local laws and regulations regarding laws governing helmet use and DeltaWing operation in your area.

FAILURE TO USE COMMON SENSE AND HEED THE ABOVE WARNINGS FURTHER INCREASES RISK OF SERIOUS INJURY. USE AT YOUR OWN RISK AND WITH APPROPRIATE AND SERIOUS ATTENTION TO SAFE OPERATION. USE CAUTION.

BEFORE YOU BEGIN

Remove contents from box and check parts against part diagram below. Remove the separators that protect the components from damage during shipping. Inspect the contents of the box for scratches in the paint, dents or kinked cables that may have occurred during shipping. Because the DeltaWing is partially assembled and packed at the factory, there should not be any problems even if the box has a few scars or dents.

Estimated Assembly and Set-Up Time

Allow up to 15–20 minutes for assembly. Razor recommends assembly by an adult.

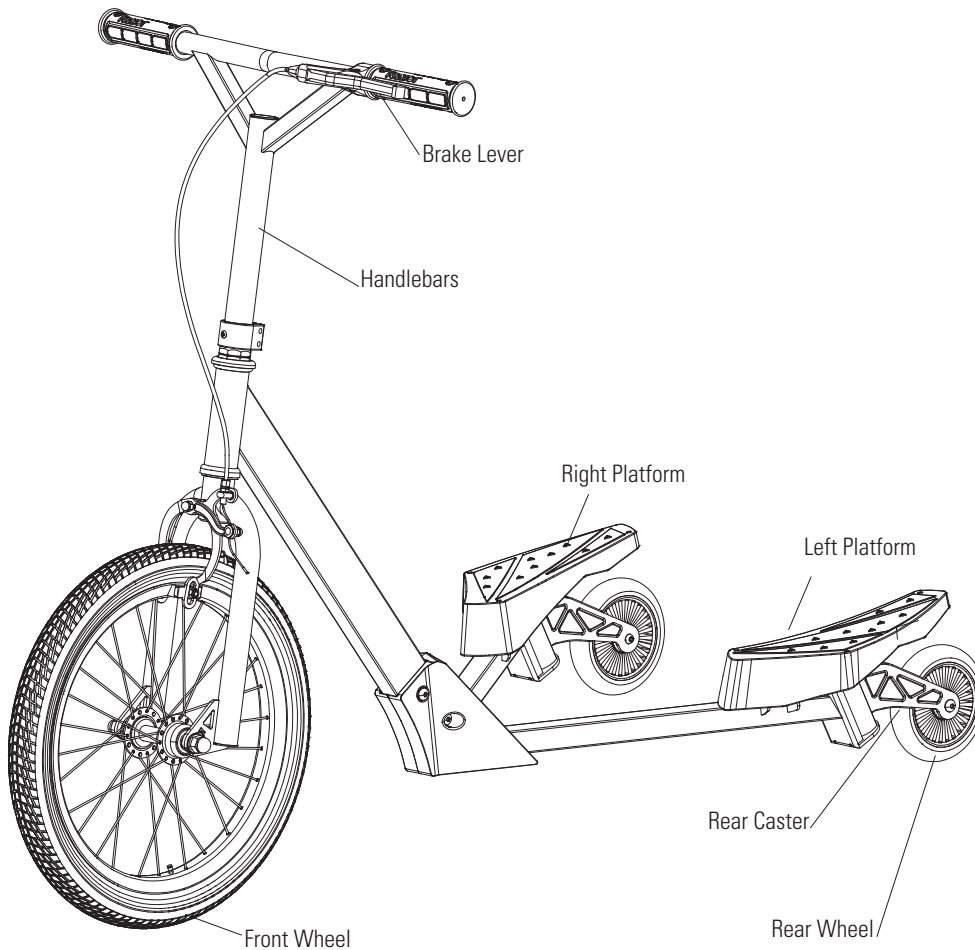

Required Tools

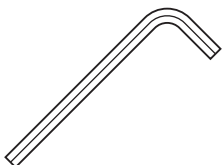

Two (2) 5 mm
Allen Wrenches

WARNING: DO NOT USE NON-RAZOR PRODUCTS WITH YOUR DELTAWING. The DeltaWing has been built to certain Razor design specifications. The original equipment supplied at the time of sale was selected on the basis of its compatibility with the frame, fork and all other parts. Certain aftermarket products may not be compatible and will void the warranty.

Product I.D. Code

1. Side of Frame
2. Barcode on Side of Box (not shown)

Box Contents:

- DeltaWing
- Allen Wrenches
- Owner's Manual

Need Help? Visit our web site for replacement parts, product support, a list of authorized service centers in the US and customer service contact information at www.razor.com. Please have the product I.D. code (located on the white label of your product) available for better assistance. Additional Customer Service contact information is listed at the back of this manual.

ASSEMBLY AND SET-UP

Attaching the Front Wheel Assembly

Tools Required: Two (2) 5 mm Allen wrenches

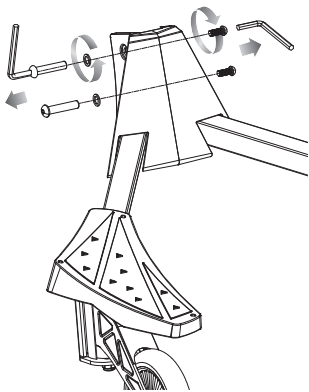

1 Using two (2) 5 mm Allen wrenches, remove the two coupling bolts from the frame.

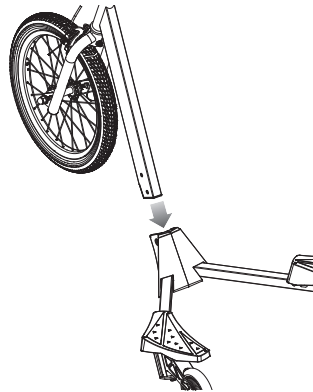

2 Insert the front wheel assembly into the frame and align the holes on the downtube with the holes on the frame.

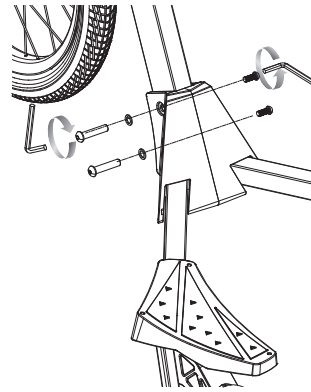

3 Reinsert coupling bolts. Tighten using two (2) 5 mm Allen wrenches.

WARNING: Failure to properly install the front wheel assembly and handlebars may cause the rider to lose control and fall. If you are having difficulty understanding these instructions, please contact Razor Customer Service for assistance.

WARNING: Failure to properly install the front wheel assembly and handlebars may cause the rider to lose control and fall. If you are having difficulty understanding these instructions, please contact Razor Customer Service for assistance.

Attaching the Handlebars

Tools Required: 5 mm Allen wrench

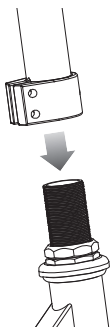

1 Insert the handlebars onto the front fork. You may need to slightly loosen the collar clamp using a 5 mm Allen wrench to allow the handlebars to slip onto the front fork. **Note:** The cable and wire brake assembly must not wrap around the handlebars. Sharp bends or twisting of the brake cable can cause the brake to malfunction.

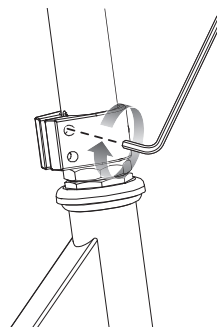
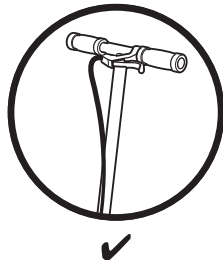
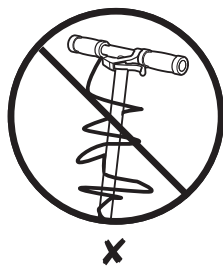

2 Using a 5 mm Allen wrench, tighten the two (2) bolts on the collar clamp. The collar clamp is properly tightened when the handlebars cannot be twisted out of alignment with the front wheel. **Note:** Make sure the front wheel is pointed straight ahead, the handlebars square to the front wheel, and the Razor logo facing the front.

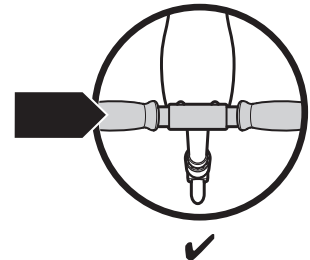
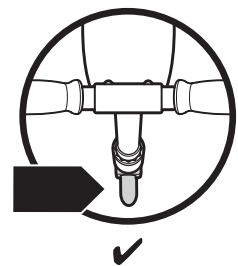

Inflating the Tire

The tire is inflated when shipped, but it invariably may lose some pressure between the point of manufacturing and your purchase. **Always inflate tire to the correct PSI before first time use.**

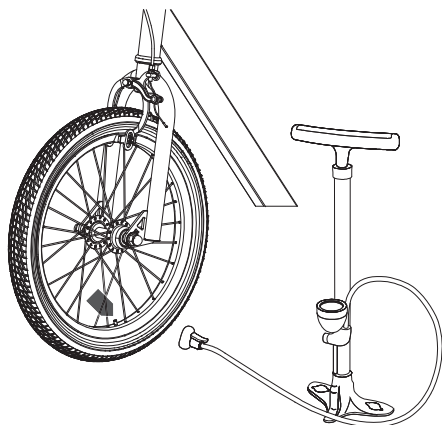

1 Using a bicycle-style tire pump equipped for a Schrader-type valve, inflate the front tire to the correct PSI indicated on the sidewall of the tire.

WARNING: Do not over inflate, as this could damage tire or wheel.

Note: The pressurized air supplies found at gasoline stations are designed to inflate high-volume automobile tires. If you decide to use such an air supply to inflate your DeltaWing tire, first make sure the pressure gauge is working, then use very short bursts to inflate to the correct PSI. If you inadvertently over-inflate the tire, release the excess pressure immediately.

PRE-RIDE CHECKLIST



Brake

Check the brake for proper function. When you squeeze the lever, the brake should provide positive braking action.



Loose Parts

Check and secure all fasteners before every ride. Make sure the collar clamp bolts and platforms are tight. There should not be any unusual rattles or sounds from loose parts or broken components. If you are not sure, call 1-866-467-2967 for assistance.



Frame, Fork and Handlebars

Check for cracks or broken connections. Although broken frames are rare, it is possible for an aggressive rider to run into a curb or wall and wreck, bend or break a frame. Get in the habit of inspecting yours regularly.



Safety Gear

Always wear proper protective equipment, such as an approved safety helmet, elbow pads and kneepads. Always wear shoes (lace-up with rubber soles) and keep shoelaces tied and out of the way of the wheels. Never ride barefooted or in sandals.

USAGE

How to Ride

Place both hands on the handlebars. Place one foot on the platform directly above the caster. Push off with the other foot then place foot on the other platform directly above the caster. Slightly bend knees. With handlebars straight, swing hips and legs side to side. Shifting weight on the platforms from right to left in sync with hips and legs. The side to side motion acts to self propel the DeltaWing. No pushing required.

How to Stop

Apply hand brake.

Step off the DeltaWing to the side or rear. Do not step or jump in front of moving DeltaWing platforms.

Note: Do not step off of platforms until unit has come to a complete stop.

Need Help? Visit our web site for replacement parts, product support, a list of authorized service centers in the US and customer service contact information at www.razor.com. Please have the product I.D. code (located on the white label of your product) available for better assistance. Additional Customer Service contact information is listed at the back of this manual.

REPAIR AND MAINTENANCE

❑ Cleaning

Wipe with a damp cloth to remove dirt and dust. Do not use industrial cleaners or solvents as they may damage the surfaces. Do not use alcohol, alcohol-based or ammonia-based cleaners as they may damage or dissolve the plastic components or soften the decals or decal adhesive.

❑ Testing the Brake

To use the brake, squeeze the lever to increase the pressure on the brake. The brake lever is fitted with a cable adjuster to compensate for cable stretch and/or to fine-tune the lever movement to brake engagement. If brake is not engaging properly, follow instructions for adjusting the brakes.

❑ Adjusting the Brake

Tools Required: 10 mm Wrench

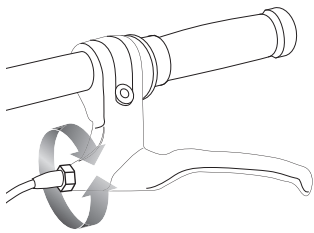

1 To adjust brake cable play, thread the brake lever adjuster in or out 1/4 to 1/2 turn until the desired brake adjustment is attained. Most adjustments are complete at this step. If brake still needs further adjustment, proceed to step 2.

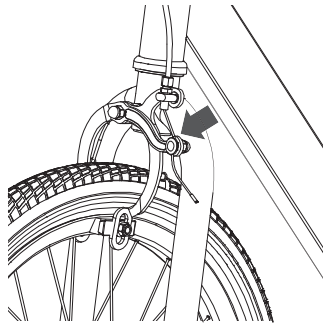

2 If brake is too tight or has too much slack, use a 10 mm wrench to loosen the brake cable and adjust accordingly.

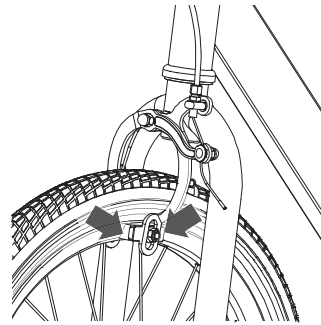

3 Inspect the brake pads for proper alignment against the wheel or excess wear. To realign brake pads, loosen the fixing nut and adjust the pad to contact the rim. Re-tighten and readjust as needed. Verify proper brake function prior to riding.

❑ Wheels and Bearings

Under normal circumstances and conditions, Razor wheels and wheel bearings are maintenance free. Nonetheless, it is the responsibility of the owner or guardian to periodically inspect the wheels for wear and tear, the axle for proper tightness, and bearings for side-to-side play, and loose parts. When a wheel or wheel bearing develops play, this is an indication of excess wear and replacement is necessary. Replace immediately with only genuine Razor wheels. Worn wheels/bearings are considered normal wear-and-tear and are not covered by the Razor Warranty. Wheels other than genuine Razor wheels may not be compatible with your Razor DeltaWing. The use of anything other than genuine Razor replacement parts may affect your safety and will void your warranty.

❑ Replacement Parts

The most frequently requested replacement parts are available for purchase at some Razor retail partners. For the complete selection of replacement parts visit shop.razor.com.

❑ Repair Centers

For a list of authorized Razor repair centers:

- Check online at www.razor.com.
- Additional Customer Service contact information is listed at the back of this manual.

Need Help? Visit our web site for replacement parts, product support, a list of authorized service centers in the US and customer service contact information at www.razor.com. Please have the product I.D. code (located on the white label of your product) available for better assistance. Additional Customer Service contact information is listed at the back of this manual.

DELTAWING PARTS

Keep your DeltaWing working for years with genuine Razor parts. Visit our web site www.razor.com to purchase replacement parts. (Specifications subject to change without notice.)

- | | | |
|--------------------------|----------------------------------|-------------------------|
| 1. Handlebar Grips (x2) | 7. Caliper Brake with Brake Pads | 9. Caster (x2) |
| 2. Handlebars | 8. Front Wheel Complete | 9-1 Caster Bolt (x2) |
| 3. Brake Lever Assembly | 8-1 Cap Nuts (x2) | 10. Rear Wheel (x2) |
| 4. Collar Clamp | 8-2 Spring Washer (x2) | 10-1 Axle Bolt (x2) |
| 5. Headset (Upper/Lower) | 8-3 Safety Washer (x2) | 11. Right/Left Platform |
| 6. Front Fork | | |

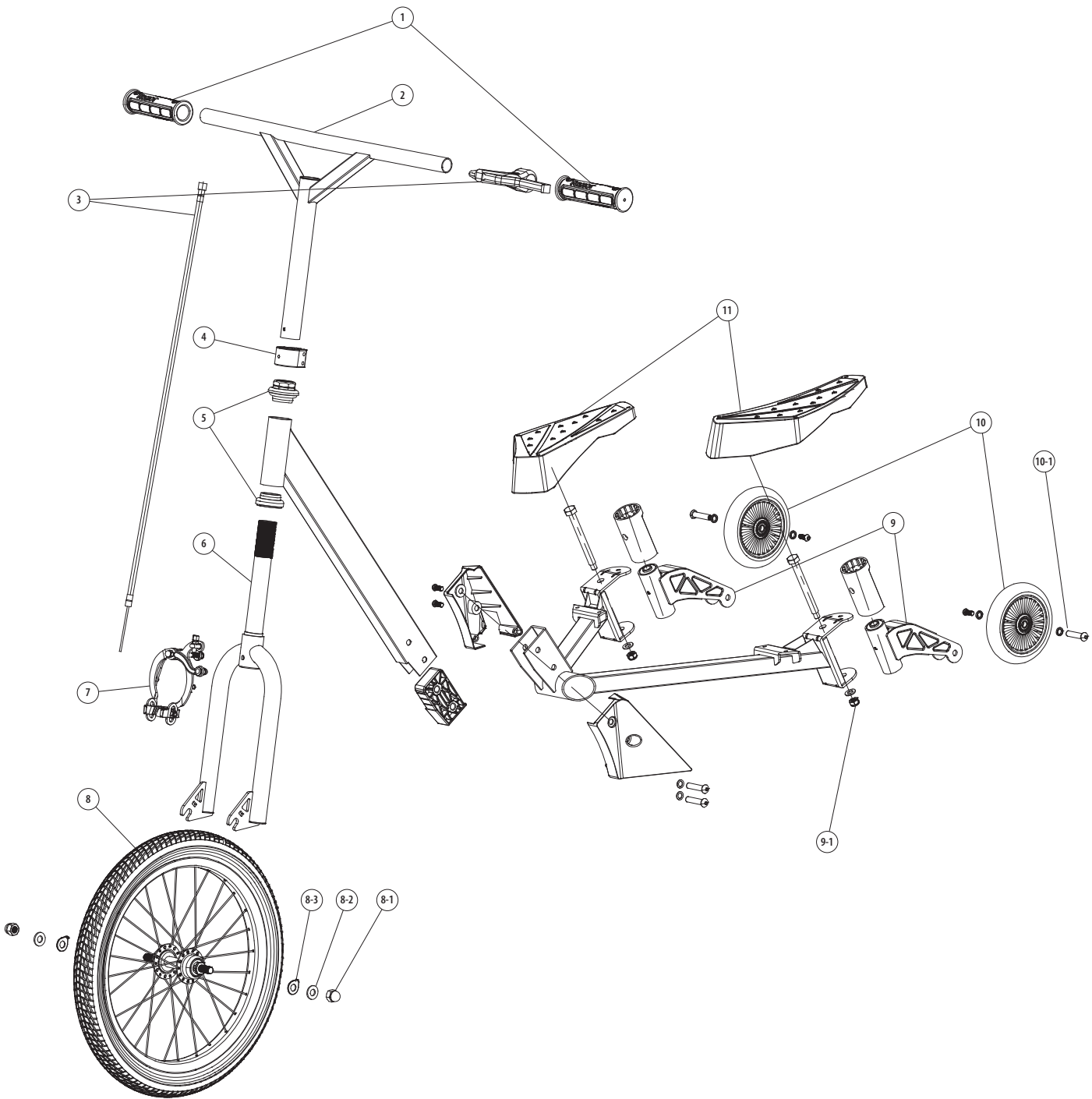

WARRANTY

Razor Limited Warranty

The manufacturer warrants this product to be free of manufacturing defects for a period of 6 months from date of purchase. This Limited Warranty does not cover normal wear and tear, wheels, or any damage, failure or loss caused by improper assembly, maintenance, storage or use of the Razor DeltaWing.

This Limited Warranty will be void if the product is ever:

- used in a manner other than for recreation;
- modified in any way;
- rented.

The manufacturer is not liable for incidental or consequential loss or damage due directly or indirectly to the use of this product.

Razor does not offer an extended warranty. If you have purchased an extended warranty, it must be honored by the store at which it was purchased.

For your records, save your original sales receipt with this manual.

CUSTOMER SERVICE CONTACT INFORMATION

Need Help? Visit our web site for replacement parts, product support, a list of authorized service centers in the US and customer service contact information at www.razor.com. Please have the product I.D. code (located on the white label of your product) available for better assistance. Additional Customer Service contact information is listed below:

UNITED STATES

Razor USA LLC
P.O. Box 3610
Cerritos, CA 90703
USA

+1 866 467 2967
Monday - Friday
8:00 AM - 5:00 PM Pacific Time

EUROPE

Razor USA (Europe)
Handelsweg 2
2742 RD Waddinxveen
Netherlands

+44 (0) 120 267 2702

ASIA

Razor USA (Asia)
P.O. Box 3610
Cerritos, CA 90703
USA

+81 50 7579 6622
info@razor-asia.com

DISTRIBUTED IN THE UK BY:

Re:creation Limited
2 Meadows Business Park
Station Approach, Blackwater
Camberley, Surrey GU17 9AB
United Kingdom

+44 (0) 118 973 6222 Tel
+44 (0) 118 973 6220 Fax
sales@recreationltd.co.uk

DISTRIBUTED IN AUSTRALIA BY:

Funtastic Limited
Level 2, Tower 2, Chadstone Place
1341 Dandenong Road
Chadstone VIC 3148
Australia

+1 800 244 543

Printed in China for:
Razor USA LLC
PO Box 3610
Cerritos, CA 90703

Copyright © 2003-2014 Razor USA, LLC. All rights reserved. Razor® and the Razor logo design are among the registered trademarks of Razor USA LLC in the United States and/or select foreign countries. DeltaWing™ is a trademark of Razor USA LLC.